

(bedcolab)

Vanguard laboratory fume hoods



H. H. HAWKINS LTD.
laboratory fume hoods & casework



[Secure Containment fume hoods]

Vanguard laboratory fume hoods

- 1 Fluorescent light fixture with sealed glass offering a safe and bright working area (80 foot candles)
- 2 Sturdy 18 gauge exterior shell available with SEFA-8 superior chemical resistant paint finish
- 3 Large louvered by-pass area for optimal air balancing
- 4 30³/₄" high cavity opening for superior interior viewing
- 5 Generous 26¹/₂" interior working depth while maintaining an overall 32³/₄" exterior dimension
- 6 Optional pre-plumbed service fixtures using approved flexible materials
- 7 Interior lining components are available in non-metallic or stainless steel finishes
- 8 Aerodynamic sash opening designed for minimal air turbulence



- 9 Self supporting steel structure adding strength and flexibility
- 10 All Electrical components are CSA/UL approved and prewired for final single point connection
- 11 Optional audible and visible low velocity alarm
- 12 All electrical and plumbing components are safely located outside of the hood chamber
- 13 Laminated safety glass sash
- 14 Optional sash stops
- 15 Interior access panels are removable and easily replaceable without the use of special tools
- 16 Convenient pre-punched interior & exterior service holes for services fixtures
- 17 Factory set interior baffles
- 18 Stainless steel air foil designed with electrical cord access

(Engineered to lead)

Bedcolab is proud to present its newest line of laboratory fume hoods, the Vanguard. We combined extensive customer research, a rigorous R&D program and over 25 years of fume hood manufacturing experience to design a high performance high value hood that is perfectly adapted to the new realities of the modern laboratory environment. We wanted our new hood to provide ultimate performance in terms of containment safety, energy efficiency and space utilization. The Vanguard meets these challenges head on.

Secure Containment

The most important performance criteria of a laboratory fume hood is certainly the security of the laboratory personnel. With containment first and foremost in our minds, the Vanguard hood was designed in a rigorous ISO 9001:2000 framework using advanced 3-D engineering and rendering software. Each component of the Vanguard was designed to provide peak aerodynamic performance. Once we were satisfied with the computer models, we moved on to prototyping and months of testing to fine tune the design. The results not only exceeded all industry containment standards, they even exceeded our own expectations.

Low Velocity

Reducing customer operating costs was another chief objective of our design team. By focusing our effort on critical airflow paths, the Vanguard achieves superior containment even with face velocities down to 60 fpm without having to resort to restricted sash openings, additional motors and fans or complex mechanized systems.

Building Ergonomics

Because the fume hood is a main consideration in the scope of a laboratory installation, we included infrastructure and building related requirements as part of our initial design criteria. We wanted our new hood to be building friendly. We have succeeded in maximizing interior dimensions while offering exterior dimensions that allow for easy handling and installation in existing facilities and optimized room layout for new design labs.



(Vanguard laboratory fume hoods, true high performance by design)

(Secure Containment)

Laboratory personnel safety is the primary performance criteria of a fume hood. Vanguard's Critical Airflow Path (CAP) design includes a high containment baffle configuration that controls and increases the air velocity within the hood to create a constant laminar flow at the face opening.

To confirm our own research we had our hoods tested by SIEMENS, a recognized independent testing company, using the ASHRAE 110-1995 AM protocol. Face velocities of 100 FPM and 60 FPM were used and in both cases performance results far exceeded industry standards.

Superior Containment even at lower face velocities*

Industry Standard
ANSI/AIHA Z9.5-2003
.05 ppm

Example: VBA-48 with full sash open	
Vanguard at 100 fpm	Vanguard at 60 fpm
0.001 ppm	0.003 ppm

* Results taken from Siemens test reports

Superior face velocity uniformity even at lower face velocities*

Industry Standard
ANSI/AIHA Z9.5-2003
+20%
- 20%

Example: VBA-48 with full sash open	
Vanguard at 100 fpm	Vanguard at 60 fpm
+7.1%	+8.6%
- 5.1%	- 6.4%

* Results taken from Siemens test reports

Vanguard laboratory fume hoods meet or exceed the following industry standards:

- ✓ **SEFA 1-2002** Laboratory Fume Hoods Recommended Practices
- ✓ **ANSI/AIHA Z9.5-2003** An American National Standard for Laboratory Ventilation
- ✓ **ASHRAE** Handbook Applications 1999
- ✓ **MD 15128** Laboratory Fume Hoods
- ✓ **CSA Standard C22.2 No. 1010.1-92 & CSA-US**
- ✓ **NFPA 45, 2000** National Fire Protection Association
- ✓ **OSHA 1910.1450** Occupational Exposure to Hazardous Chemicals in Laboratories
- ✓ **Prudent Practices in the Laboratory: Handling and Disposal of Chemicals (1995)**, National Research Council
- ✓ **Industrial Ventilation** (24th Edition)



(Low velocity capability)

In appropriate laboratory environments, low velocity fume hoods are an effective tool for designers and facilities managers who want to build green and maximize economic and environmental performance. Their low exhaust volume can considerably reduce a laboratory's energy consumption. In addition to reduced operating costs, a low velocity hood set-up can also significantly reduce HVAC infrastructure costs as described on page 4.

The performance of a fume hood is measured by it's ability to flow air cleanly through the hood and away from the user. We focused on the critical airflow paths to provide optimal containment and then further improved the design to maintain high performance at reduced face velocities.

The Vanguard was designed using advanced 3-D engineering software. The computer models helped us shape the airflow within the parameters of conventional laboratory use, and the subsequent months of fine-tuning allowed us to effectively maintain superior containment with face velocities down to 60 fpm. Numerous minute adjustments were tested in our in house testing facility to further eliminate turbulence and dead air pockets. The result is true high performance by design. With the Vanguard there is no need to work with restrictive sash openings to reduce the amount of exhausted air, it's performance numbers are achieved with a full open sash.

Exhaust data comparison with 26 1/4" full open sash

Hood size	Opening dimensions	Duct collar size	With a 100 feet/minute velocity			With a 60 feet/minute velocity		
			Exhaust CFM	Duct collar air speed	Static pressure loss	Exhaust CFM	Duct collar air speed	Static pressure loss
48"	38 1/2" x 26 1/4"	10" diameter	728 cfm	1334 fpm	0.18"	437 cfm	801 fpm	0.065"
60"	50 1/2" x 26 1/4"	12" diameter	955 cfm	1215 fpm	0.25"	573 cfm	730 fpm	0.09"
72"	62 1/2" x 26 1/4"	12" diameter	1183 cfm	1506 fpm	0.30"	710 cfm	904 fpm	0.15"
96"	86 1/2" x 26 1/4"	2 x 10" diameter	1636 cfm	1499 fpm	0.20"	982 cfm	900 fpm	0.08"

Another clear benefit of operating hoods at low velocities is the comfort gain for the laboratory personnel. The reduction in face velocities results in less drafty conditions and considerably increases the comfort level in the lab.



Green by Design

Building ergonomics

Designing a new lab or renovating an existing one is a complex undertaking, especially when trying to incorporate high performance fume hoods. The Vanguard is designed to be building friendly. When set-up for low velocities, it minimizes infrastructure first costs while offering true high performance for reduced operating costs.

Contrary to most other low velocity hoods that resort to bulky blowers, fans or complex mechanized systems to achieve containment at low velocities, the Vanguard's Critical Airflow Path (CAP) design allows for maximum space utilization and building ergonomics while providing generous interior dimensions. It also offers an exceptional cost/benefit ratio because it virtually eliminates maintenance and repair costs.

Its compact $32\frac{3}{4}$ " O/A. depth allows easy ingress to the laboratory through standard 36" door openings. Minimal overhang on the isle bench means that centre to centre dimensions between isles can be held to the safe regulatory minimum, optimizing the lab floor plan and resulting in major savings in construction costs, especially in the case of multi hood layouts.

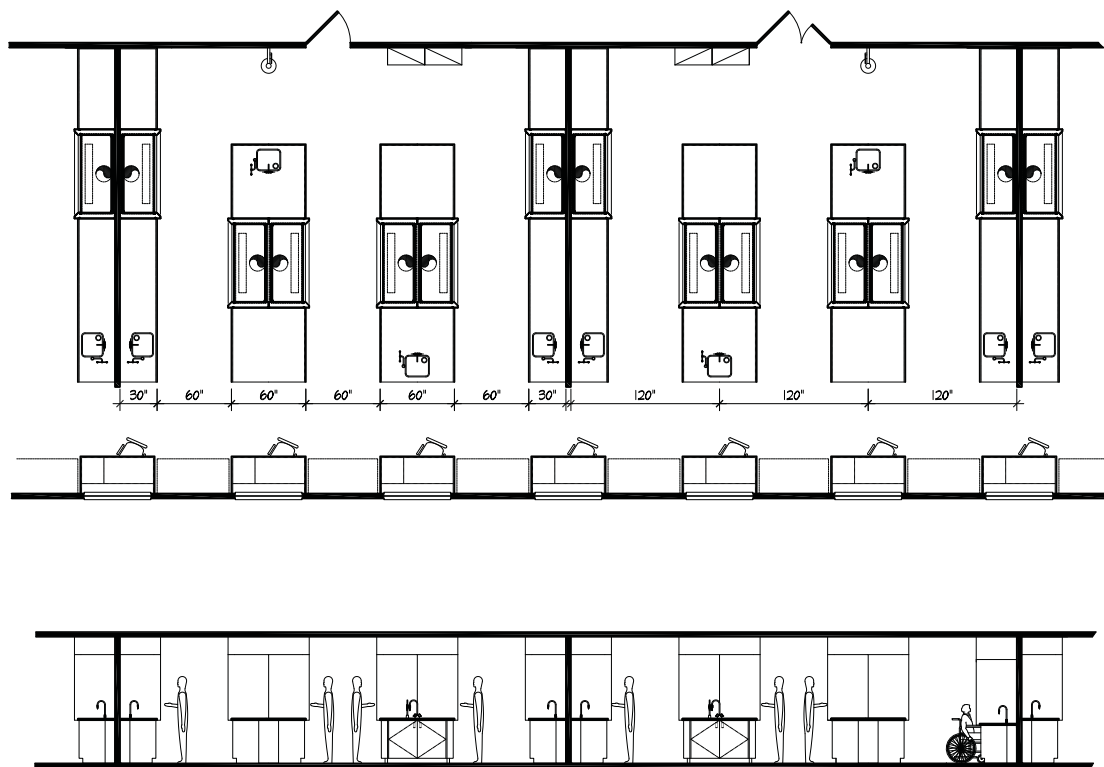

When set up for lower face velocities the reduced CFM requirements can translate into significantly reduced infrastructure and building costs such as smaller ducting and mechanical requirements as well as lower floor heights.

With its low standard 86" duct height and 95" sash top height, the Vanguard's high performance benefits can also be incorporated into existing building renovations with low ceiling heights.

- 1 Compact 32³/₄" O/A depth for easy ingress through standard 36" doors
- 2 Reduced space for mechanicals when set up for low velocities
- 3 95" sash top height to work with existing 8 ft ceilings
- 4 Low 86" duct height while maintaining standard industry 48" inside height.
- 5 The sash forward design with its generous 26¹/₂" interior working depth allows the lab technician to use the full depth of the hood cavity without having to reach in and compromise his safe breathing zone
- 6 Tall 67³/₄" view height with standing height base cabinet

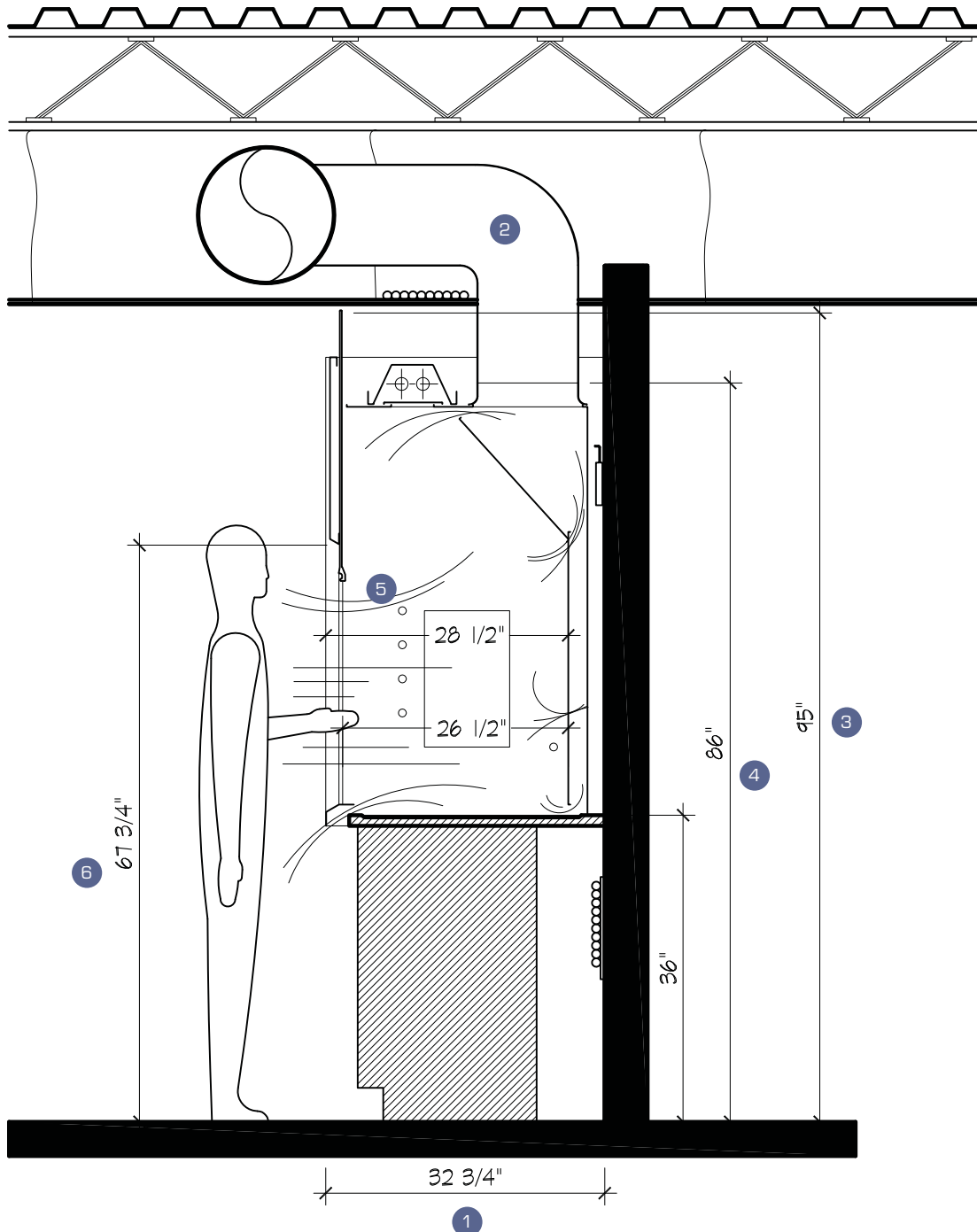

Section view Additional dimensions shown on pages 6 & 7

Typical top views

Dimensions apply to all Vanguard Fume Hoods unless otherwise noted on the **Fume Hood Specifications sheet**.

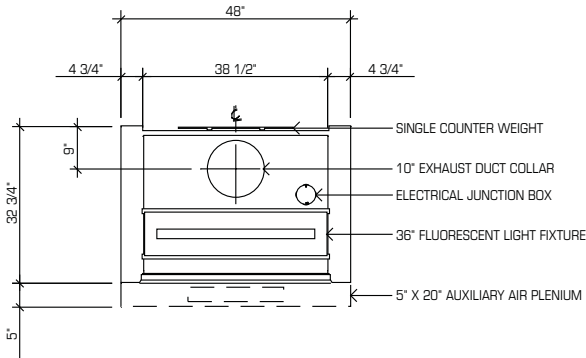

Dimensions apply to all 48" Fume Hoods

Model number	
VBA-48	Page 8
VBV-48	Page 9
VBI-48	Page 10
VBH-48	Page 11
VBR-48	Page 12
VBP-48	Page 13

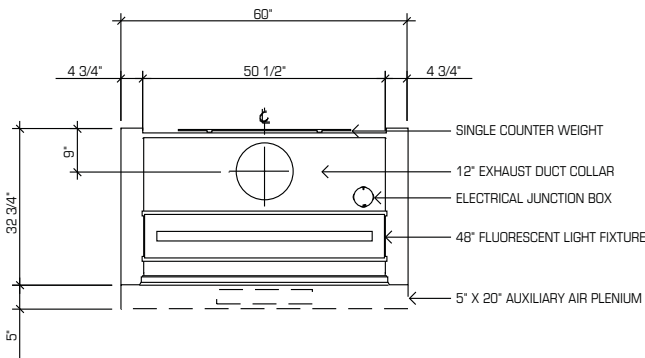

Dimensions apply to all 60" Fume Hoods

Model number	
VBA-60	Page 8
VBV-60	Page 9
VBI-60	Page 10
VBH-60	Page 11
VBR-60	Page 12
VBP-60	Page 13

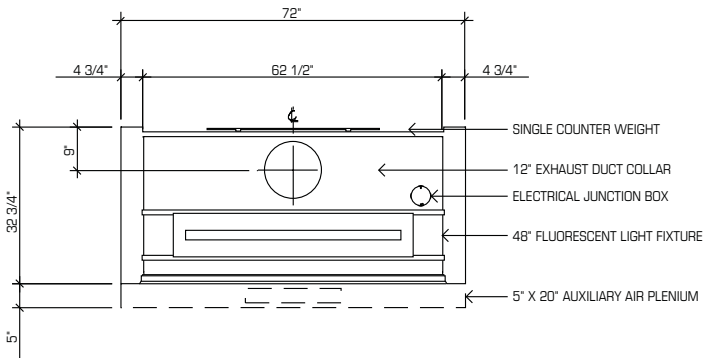

Dimensions apply to all 72" Fume Hoods

Model number	
VBA-72	Page 8
VBV-72	Page 9
VBI-72	Page 10
VBH-72	Page 11
VBR-72	Page 12
VBP-72	Page 13

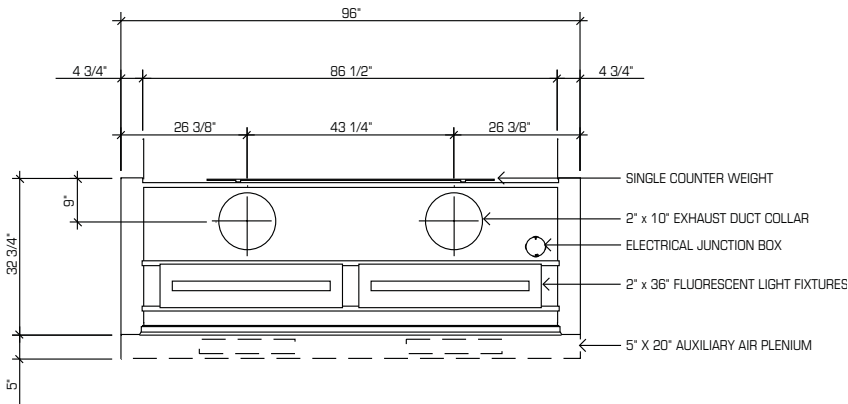

Dimensions apply to all 96" Fume Hoods

Model number	
VBA-96	Page 8
VBV-96	Page 9
VBI-96	Page 10
VBH-96	Page 11
VBR-96	Page 12
VBP-96	Page 13

Typical Cross Sections

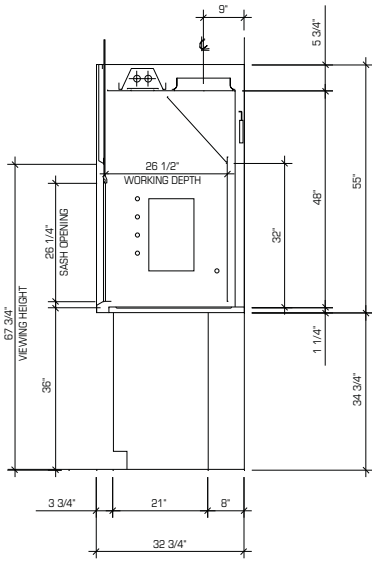

Balanced Air Fume Hood

Model number

VBA-48	VBA-72
VBA-60	VBA-96

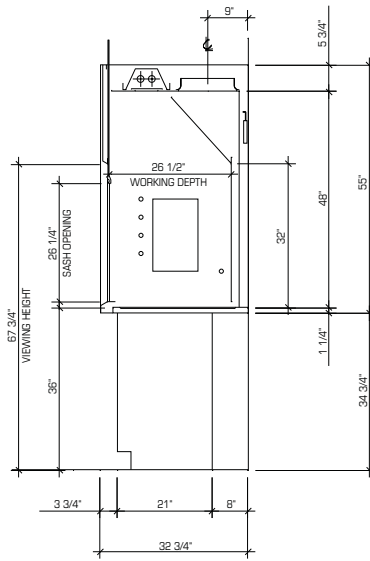

Variable Air Volume Fume Hood (VAV)

Model number

VBV-48	VBV-72
VBV-60	VBV-96

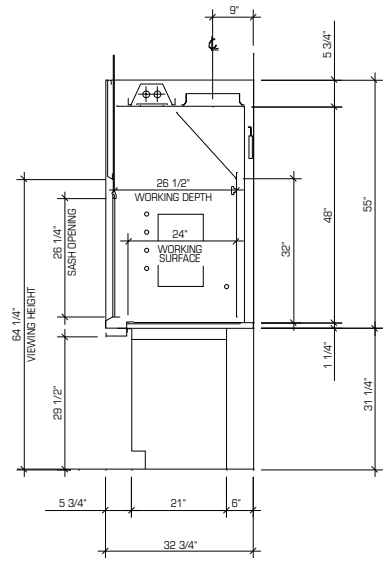

Fully Accessible Fume Hood (ADA)

Model number

VBH-48	VBH-72
VBH-60	VBH-96

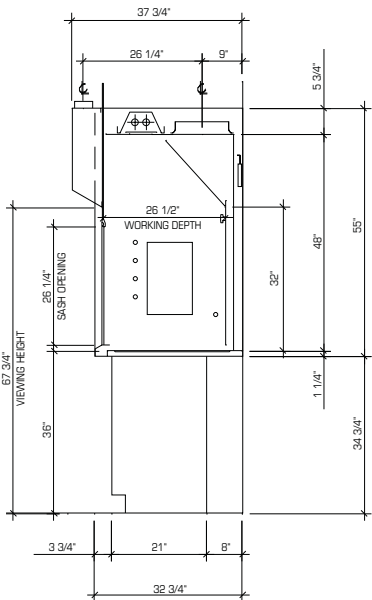

Auxiliary Air Fume Hood

Model number

VBI-48	VBI-72
VBI-60	VBI-96

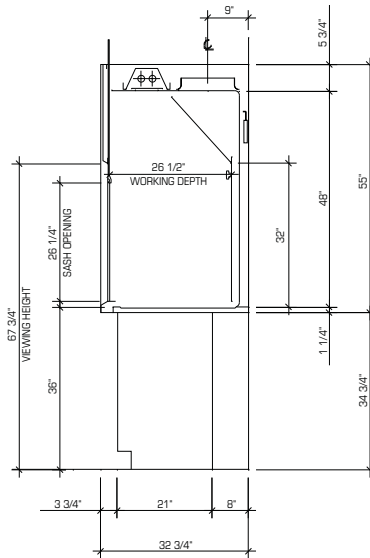

Radio Isotope Fume Hood

Model number

VBR-48	VBR-72
VBR-60	VBR-96

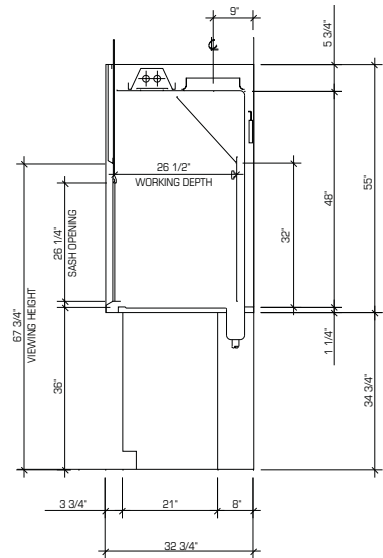

Perchloric Acid Fume Hood

Model number

VBP-48	VBP-72
VBP-60	VBP-96

Vanguard - Balanced Air Fume Hood

Widely used in hospitals, industrial labs and research facilities, the Balanced Air Fume Hood controls the air velocity through the hood. With conventional hoods, face velocity becomes excessive when the sash is at a lower position, disturbing the work being conducted inside the hood. This inconvenience is reduced with the balanced air fume hood because it maintains a more constant face velocity. When the sash is lowered, air is fed through the louvered top section as well as through the aerodynamic airfoil located under the sash creating a sweeping air movement at the work surface to reduce dead-air pockets and air turbulence at the work surface front.

These upper and lower bypasses allow the hood to be effectively purged while the work inside remains undisturbed. These hoods are designed to be mounted to a 30" deep 1 1/4" thick counter top.



Features:

- ✓ Generous 26 1/2" interior depth
- ✓ Tall front opening view height of 67 3/4" with standard 36" base cabinets
- ✓ Vertical rising sash
- ✓ Upper and lower by passes
- ✓ Aerodynamic air foil with electrical cord access
- ✓ Factory set interior baffles
- ✓ Fluorescent lamp, light switch and two duplex electrical outlets 120V/15A with internal wiring to a junction box
- ✓ Front corner posts & interior side panels pre-punched to accept up to 10 plumbing fixtures
- ✓ Removable and easily replaceable interior access panel in each side wall for plumbing access
- ✓ Removable exterior side panels
- ✓ Choice of liner as per Fume hood Specification Sheet

Catalogue No.	Exterior Dimensions			Face Opening	Interior Dimensions			Viewing dimensions
	Width	Depth	Height		Width	Depth	Height	
VBA-48	48"	32 3/4"	55"	38 1/2" x 26 1/4"	38 1/2"	26 1/2"	48"	38 1/2" x 30 3/4"
VBA-60	60"	32 3/4"	55"	50 1/2" x 26 1/4"	50 1/2"	26 1/2"	48"	50 1/2" x 30 3/4"
VBA-72	72"	32 3/4"	55"	62 1/2" x 26 1/4"	62 1/2"	26 1/2"	48"	62 1/2" x 30 3/4"
VBA-96	96"	32 3/4"	55"	86 1/2" x 26 1/4"	86 1/2"	26 1/2"	48"	86 1/2" x 30 3/4"

- ✓ Exhaust data shown on page 3
- ✓ Additional dimensions shown on pages 6 & 7
- ✓ Base cabinet options shown on pages 14 & 15

- ✓ Optional accessories shown on pages 16 & 17
- ✓ Fume hood specifications sheet shown on page 19

Vanguard - Variable Air Volume Fume Hood (VAV)

The Variable Air Volume fume hood combined with an HVAC control system is designed to vary the hood's exhaust rate to maintain a constant average face velocity throughout the sash travel. In addition the aerodynamic airfoil located under the sash creates a sweeping air movement at the work surface to reduce dead-air pockets and air turbulence at the work surface front.

The VAV system has a higher initial cost than the conventional installation due to the complexity of the control system, however it offers reduced energy consumption for long term savings. These hoods are designed to be mounted to a 30" deep x 1 1/4" thick counter top.



Features:

- ✓ Generous 26 1/2" interior depth
- ✓ Tall front opening view height of 67 3/4" with standard 36" base cabinets
- ✓ Vertical rising sash
- ✓ Upper and lower by passes with interior adjustable top front cover
- ✓ Pre-punched to accommodate HVAC controls
- ✓ Aerodynamic air foil with electrical cord access
- ✓ Factory set interior baffles
- ✓ Fluorescent lamp, light switch and two duplex electrical outlets 120V/15A with internal wiring to a junction box
- ✓ Front corner posts & interior side panels pre-punched to accept up to 10 plumbing fixtures
- ✓ Removable and easily replaceable interior access panel in each side wall for plumbing access
- ✓ Removable exterior side panels
- ✓ Choice of liner as per Fume hood Specification Sheet

Catalogue No.	Exterior Dimensions			Face Opening	Interior Dimensions			Viewing dimensions
	Width	Depth	Height		Width	Depth	Height	
VBV-48	48"	32 3/4"	55"	38 1/2" x 26 1/4"	38 1/2"	26 1/2"	48"	38 1/2" x 30 3/4"
VBV-60	60"	32 3/4"	55"	50 1/2" x 26 1/4"	50 1/2"	26 1/2"	48"	50 1/2" x 30 3/4"
VBV-72	72"	32 3/4"	55"	62 1/2" x 26 1/4"	62 1/2"	26 1/2"	48"	62 1/2" x 30 3/4"
VBV-96	96"	32 3/4"	55"	86 1/2" x 26 1/4"	86 1/2"	26 1/2"	48"	86 1/2" x 30 3/4"

- ✓ Exhaust data shown on page 3
- ✓ Additional dimensions shown on pages 6 & 7
- ✓ Base cabinet options shown on pages 14 & 15

- ✓ Optional accessories shown on pages 16 & 17
- ✓ Fume hood specifications sheet shown on page 19

Vanguard - Auxiliary Air Fume Hood

Ideally suited to labs with limited HVAC capacity, the Auxiliary Air Fume Hood controls air velocity in much the same way as the Balanced Air Hood. In addition the Auxiliary Air Hood features an upper front intake plenum to reduce the consumption of conditioned room air. This auxiliary air is introduced outside the fume hood above the sash and enters the hood through the face with the sash open. When the sash is closed, the auxiliary air is drawn into the fume hood through an opening over the sash.

Designed to be fixed a 30" deep x 1 1/4" thick counter top.



Features:

- ✓ Generous 26 1/2" interior depth
- ✓ Tall front opening view height of 67 3/4" with standard 36" base cabinets
- ✓ Vertical rising sash
- ✓ Front upper intake plenum with inside deviation filtering grills
- ✓ Aerodynamic air foil with electrical cord access
- ✓ Factory set interior baffles
- ✓ Fluorescent lamp, light switch and two duplex electrical outlets 120V/15A with internal wiring to a junction box
- ✓ Front corner posts & interior side panels pre-punched to accept up to 10 plumbing fixtures
- ✓ Removable and easily replaceable interior access panel in each side wall for plumbing access
- ✓ Removable exterior side panels
- ✓ Choice of liner as per Fume hood Specification Sheet

Catalogue No.	Exterior Dimensions			Face Opening	Interior Dimensions			Viewing dimensions
	Width	Depth	Height		Width	Depth	Height	
VBI-48	48"	32 3/4"	55"	38 1/2" x 26 1/4"	38 1/2"	26 1/2"	48"	38 1/2" x 30 3/4"
VBI-60	60"	32 3/4"	55"	50 1/2" x 26 1/4"	50 1/2"	26 1/2"	48"	50 1/2" x 30 3/4"
VBI-72	72"	32 3/4"	55"	62 1/2" x 26 1/4"	62 1/2"	26 1/2"	48"	62 1/2" x 30 3/4"
VBI-96	96"	32 3/4"	55"	86 1/2" x 26 1/4"	86 1/2"	26 1/2"	48"	86 1/2" x 30 3/4"

Intake air brought to the plenum should be a maximum of 70 % of exhaust requirements shown on page 3

- ✓ Exhaust data shown on page 3
- ✓ Additional dimensions shown on pages 6 & 7
- ✓ Base cabinet options shown on pages 14 & 15
- ✓ Optional accessories shown on pages 16 & 17
- ✓ Fume hood specifications sheet shown on page 19

Vanguard - Fully Accessible Fume Hood (ADA)

The Fully Accessible Fume Hood has the general performance characteristics as the Balanced Air hood with the addition that all services are located at an accessible height for wheel chair operators. A stainless steel spill trough is located under the front portion of the hood to prevent any chemical spillage.

Designed to be fixed to a 28¹/₂" x 1¹/₄" thick counter top.



Features:

- ✓ Generous 26¹/₂" interior depth
- ✓ Maintaining comfortable 64³/₄" view height for non ADA use
- ✓ Ergonomically adapted for ADA requirements
- ✓ Vertical rising sash
- ✓ Stainless steel spill trough under the air foil
- ✓ Aerodynamic air foil with electrical cord access
- ✓ Factory set interior baffles
- ✓ Fluorescent lamp, light switch and one duplex electrical outlet 120V/15A with internal wiring to a junction box
- ✓ Front corner posts & interior side panels pre-punched to accept up to 10 plumbing fixtures
- ✓ Removable and easily replaceable interior access panel in each side wall for plumbing access
- ✓ Removable exterior side panels
- ✓ Choice of liner as per Fume hood Specification Sheet

Catalogue No.	Exterior Dimensions			Face Opening	Interior Dimensions			Viewing dimensions
	Width	Depth	Height		Width	Depth	Height	
VBH-48	48"	32 ³ / ₄ "	55"	38 ¹ / ₂ " x 26 ¹ / ₄ "	38 ¹ / ₂ "	26 ¹ / ₂ "	48"	38 ¹ / ₂ " x 30 ³ / ₄ "
VBH-60	60"	32 ³ / ₄ "	55"	50 ¹ / ₂ " x 26 ¹ / ₄ "	50 ¹ / ₂ "	26 ¹ / ₂ "	48"	50 ¹ / ₂ " x 30 ³ / ₄ "
VBH-72	72"	32 ³ / ₄ "	55"	62 ¹ / ₂ " x 26 ¹ / ₄ "	62 ¹ / ₂ "	26 ¹ / ₂ "	48"	62 ¹ / ₂ " x 30 ³ / ₄ "
VBH-96	96"	32 ³ / ₄ "	55"	86 ¹ / ₂ " x 26 ¹ / ₄ "	86 ¹ / ₂ "	26 ¹ / ₂ "	48"	86 ¹ / ₂ " x 30 ³ / ₄ "

- ✓ Exhaust data shown on page 3
- ✓ Additional dimensions shown on pages 6 & 7
- ✓ Base cabinet options shown on pages 14 & 15

- ✓ Optional accessories shown on pages 16 & 17
- ✓ Fume hood specifications sheet shown on page 19

Vanguard - Radio Isotope Fume Hood

The design of the radio-isotope fume hood provides a safe environment for working with Isotope radiation. The fume hood has the general performance characteristics as the Balanced Air fume hood with the addition that the interior is constructed of 18 gauge type 304 #4 finish stainless steel to prevent absorption of radioactive and corrosive chemicals. The fume chamber and integral work surface consist of a welded seamless construction with all coved corners. This construction feature reduces the chance of chemical build-up and provides for a simplified and thorough decontamination

Designed to be fixed directly to the base cabinets (no counter top needed)



Features:

- ✓ Generous 26 $\frac{1}{2}$ " interior depth
- ✓ Tall front opening view height of 67 $\frac{3}{4}$ " with standard 36" base cabinets
- ✓ Vertical rising sash
- ✓ Aerodynamic air foil with electrical cord access
- ✓ Factory set interior baffles
- ✓ Fluorescent lamp, light switch and two duplex electrical outlets 120V/15A with internal wiring to a junction box
- ✓ Front corner posts pre-punched to accept up to 10 plumbing fixtures
- ✓ Removable exterior side panels (no access panel inside the hood)
- ✓ Stainless steel type 304 interior lining and counter top with coved seamless welds

Catalogue No.	Exterior Dimensions			Face Opening	Interior Dimensions			Viewing dimensions
	Width	Depth	Height		Width	Depth	Height	
VBR-48	48"	32 $\frac{3}{4}$ "	55"	38 $\frac{1}{2}$ " x 26 $\frac{1}{4}$ "	38 $\frac{1}{2}$ "	26 $\frac{1}{2}$ "	48"	38 $\frac{1}{2}$ " x 30 $\frac{3}{4}$ "
VBR-60	60"	32 $\frac{3}{4}$ "	55"	50 $\frac{1}{2}$ " x 26 $\frac{1}{4}$ "	50 $\frac{1}{2}$ "	26 $\frac{1}{2}$ "	48"	50 $\frac{1}{2}$ " x 30 $\frac{3}{4}$ "
VBR-72	72"	32 $\frac{3}{4}$ "	55"	62 $\frac{1}{2}$ " x 26 $\frac{1}{4}$ "	62 $\frac{1}{2}$ "	26 $\frac{1}{2}$ "	48"	62 $\frac{1}{2}$ " x 30 $\frac{3}{4}$ "
VBR-96	96"	32 $\frac{3}{4}$ "	55"	86 $\frac{1}{2}$ " x 26 $\frac{1}{4}$ "	86 $\frac{1}{2}$ "	26 $\frac{1}{2}$ "	48"	86 $\frac{1}{2}$ " x 30 $\frac{3}{4}$ "

- ✓ Exhaust data shown on page 3
- ✓ Additional dimensions shown on pages 6 & 7
- ✓ Base cabinet options shown on pages 14 & 15

- ✓ Optional accessories shown on pages 16 & 17
- ✓ Fume hood specifications sheet shown on page 19

Vanguard - Perchloric Acid Fume Hood

The Perchloric Acid Fume Hood has the same general performance characteristics as the Balanced Air Fume Hood with the additional feature of a coved seamless welded interior cavity using type 316 #4 finish stainless steel as recommended by Insurance Underwriters. The interior cavity also has an integral full width drain trough to facilitate the recommended frequent and thorough wash-downs. It is also recommended that the ductwork be made of a relatively inert material such as stainless steel. Exhaust ductwork should be as short and as straight as possible. Perchloric hoods must never be manifold into duct systems that serve any other type of fume hood or any other equipment.

Designed to be fixed directly to the base cabinets (no counter top needed)



Features:

- ✓ Generous 26¹/₂" interior depth
- ✓ Tall front opening view height of 67³/₄" with standard 36" base cabinets
- ✓ Vertical rising sash
- ✓ Upper and lower by passes
- ✓ Aerodynamic air foil with electrical cord access
- ✓ Factory set interior baffles
- ✓ Fluorescent lamp, light switch and two electrical outlets 120V/15A with internal wiring to a junction box
- ✓ Front corner posts pre-punched to accept up to 10 plumbing fixtures
- ✓ Removable exterior side panels
- ✓ Stainless steel type 316 interior lining and counter top with coved seamless welds
- ✓ Full width integral back trough
- ✓ A ³/₄" diameter P.V.C. spray pipe hookup to a remote controlled valve is provided for periodic wash down behind baffles

Catalogue No.	Exterior Dimensions			Face Opening	Interior Dimensions			Viewing dimensions
	Width	Depth	Height		Width	Depth	Height	
VBP-48	48"	32 ³ / ₄ "	55"	38 ¹ / ₂ " x 26 ¹ / ₄ "	38 ¹ / ₂ "	26 ¹ / ₂ "	48"	38 ¹ / ₂ " x 30 ³ / ₄ "
VBP-60	60"	32 ³ / ₄ "	55"	50 ¹ / ₂ " x 26 ¹ / ₄ "	50 ¹ / ₂ "	26 ¹ / ₂ "	48"	50 ¹ / ₂ " x 30 ³ / ₄ "
VBP-72	72"	32 ³ / ₄ "	55"	62 ¹ / ₂ " x 26 ¹ / ₄ "	62 ¹ / ₂ "	26 ¹ / ₂ "	48"	62 ¹ / ₂ " x 30 ³ / ₄ "
VBP-96	96"	32 ³ / ₄ "	55"	86 ¹ / ₂ " x 26 ¹ / ₄ "	86 ¹ / ₂ "	26 ¹ / ₂ "	48"	86 ¹ / ₂ " x 30 ³ / ₄ "

- ✓ Exhaust data shown on page 3
- ✓ Additional dimensions shown on pages 6 & 7
- ✓ Base cabinet options shown on pages 14 & 15

- ✓ Optional accessories shown on pages 16 & 17
- ✓ Fume hood specifications sheet shown on page 19

Fume Hood Base Cabinets (Forte line)

As part of our Forte laboratory casework system, these fume hood base cabinets share the same sturdy 18 gauge construction and SEFA requirements. All standing height cabinets are 34³/₄" high by 21" deep with a 3" x 4" high front toe kick.

Service Cabinets

Painted 18 gauge steel cabinets with door(s), one adjustable shelf and a fixed upper panel for mounting of services.

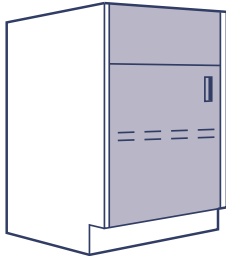

18" wide
Model #A24-18

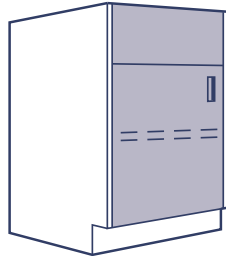

24" wide
Model #A24-24

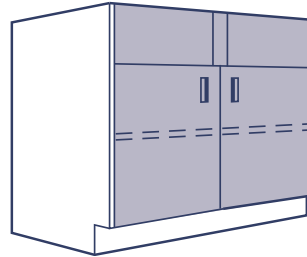

36" wide
Model #A24-36

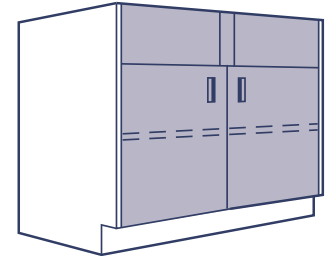

48" wide
Model #A24-48

Acid or Base Storage Cabinets*

Painted 18 gauge steel cabinets with a 3/16" polypropylene all welded one piece interior lining. Comes with one three positions perforated stainless steel shelf and "Acid" or "Base" safety identification.

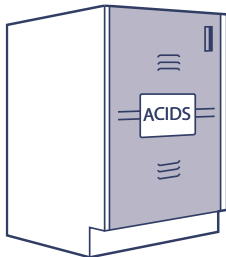

24" wide
Model #A25-24

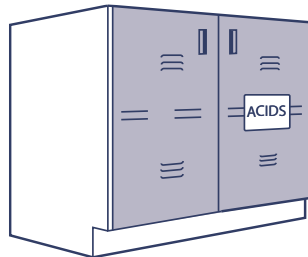

30" wide
Model #A25-30

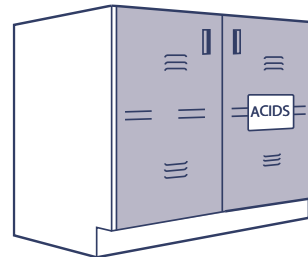

36" wide
Model #A25-36



48" wide
Model #A25-48

* Cabinets can be vented through the hood.

Solvent Storage Cabinets

Yellow painted 18 gauge steel cabinet meets O.S.H.A. Standards and comply with N.F.P.A. code no. 30 for flammable and combustible liquids. Comes with two rear fire baffle vents, one adjustable shelf and "flammable" identification. Double door are self closing. Comes only in "safety yellow" color.

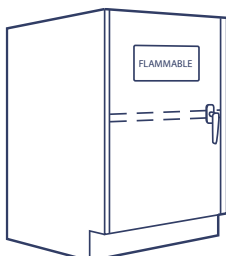

24" wide
Model #A23-24

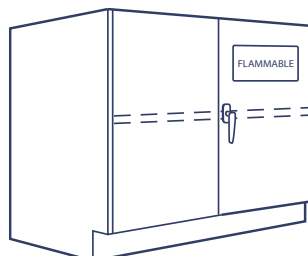

30" wide
Model #A23-30

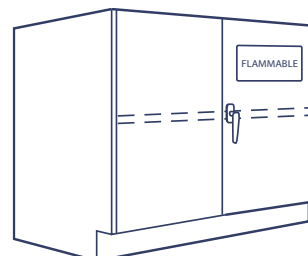

36" wide
Model #A23-36

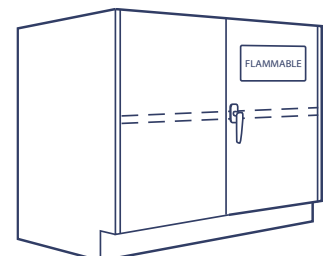

48" wide
Model #A23-48

Fume Hood Base Cabinets (Forte line)

Pump Cabinets

Painted 18 gauge steel cabinets with double wall construction for sides, back and top sections. Interior is lined with perforated painted steel panels with sound insulation in all walls. Comes with a 120V/15A electrical outlet located on the cabinet inside back, prewired to a switch located on the front top apron. Cabinet is free of floor to accommodate floor mounted Pump. Toe kick is removable for easy access.

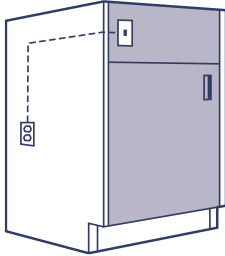

24" wide
Model #A40-24

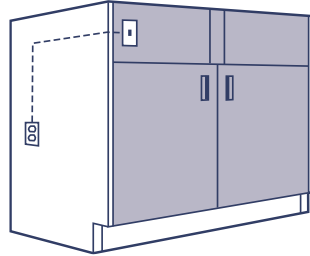

36" wide
Model #A40-36

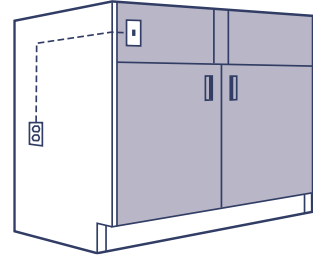

48" wide
Model #A40-48

Special Cabinets for ADA Fume Hood

Painted 18 gauge steel cabinet, bench support and panel arrangements to support the Fully Accessible Fume Hoods (ADA). Height as per local codes.

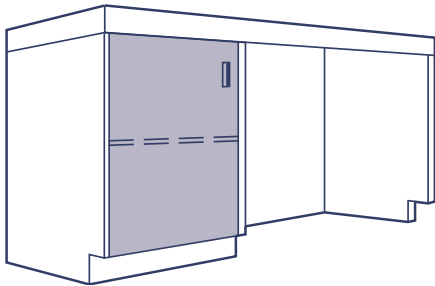

48" wide ADA Hood Support
Model #DA-100-48

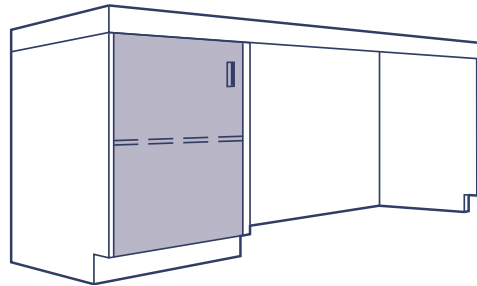

60" wide ADA Hood Support
Model #DA-100-60

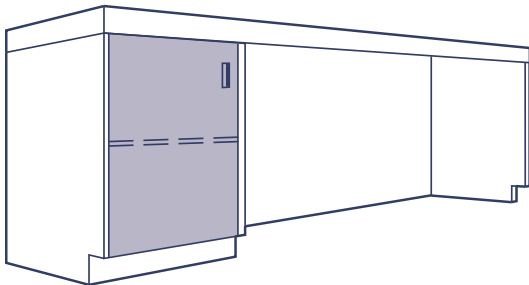

72" wide ADA Hood Support
Model #DA-100-72

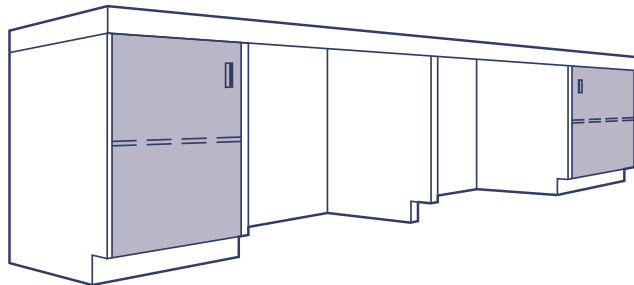

96" wide ADA Hood Support
Model #DA-100-96

Optional Accessories

Standard Dished Work Surfaces

Vanguard standard 1 1/4" dished work surfaces come with two service cut outs for access inside fume hood walls.

Surface size	Product numbers		
	Black Epoxy Resin	Stainless Steel T.316 on particle board	Stainless Steel T.316 on channel structure
* 48" x 28 1/4"	VT-EP-4828	VT-SSP-4828	VT-SSC-4828
48" x 30"	VT-EP-4830	VT-SSP-4830	VT-SSC-4830
* 60" x 28 1/4"	VT-EP-6028	VT-SSP-6028	VT-SSC-6028
60" x 30"	VT-EP-6030	VT-SSP-6030	VT-SSC-6030
* 72" x 28 1/4"	VT-EP-7228	VT-SSP-7228	VT-SSC-7228
72" x 30"	VT-EP-7230	VT-SSP-7230	VT-SSC-7230
* 96" x 28 1/4"	VT-EP-9628	VT-SSP-9628	VT-SSC-9628
96" x 30"	VT-EP-9630	VT-SSP-9630	VT-SSC-9630

* For ADA hoods only.

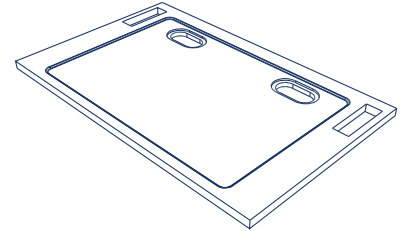

Standard Sinks and Cup Sinks

All sinks and cup sinks come with a 1 1/2" tail piece.

Products	Sizes	Product numbers	
		Black Epoxy Resin	Stainless Steel T.316
Round cup sink	6"	CS-7	SS-31
Oval cup sink	6" x 3"	CS-4	SS-30
Oval cup sink	9" x 3"	CS-12	-
EW cup sink	14 1/2" x 5 1/4"	EW-14	-
Self rimming sink	12" x 8" x 6"	E3-C	-
Self rimming sink	16" x 12" x 8"	E15-C	-
Self rimming sink	18" x 16" x 10"	-	SS3

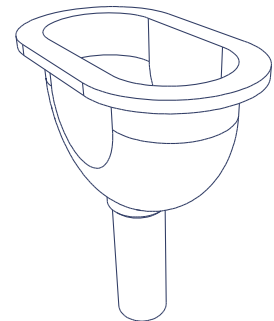

Standard Electrical Components

All electrical components are pre-wired to a junction box on top of hood.

Products	Product numbers	
	Standard items	Optional items
15A Fluorescent lamp with 2 tubes	FL-1 120V	FL-2 347V
15A Light switch on left front post	LS-1 120V	FS-2 347V
120V/15A Duplex electrical outlet	400 (2x)	-
120V/20A Duplex electrical outlet	-	401
250V/15A Electrical single outlet	-	402
250V/20A Electrical single outlet	-	403

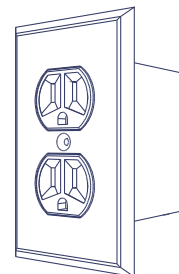

Standard Plumbing Fixtures

All plumbing fixtures have a corrosion resistant finish and come complete with a remote controlled valve.

Products	Product numbers	
	Delta	Water Saver
Water faucet with rigid gooseneck	6304-7/6350-50	L3185W-9
Water faucet with rigid gooseneck & vacuum breaker in line	6304-7/6350-59	L3185W-9/L100
Water faucet with rigid gooseneck & vacuum breaker at end of turret	6304-7/6350-60	L3185W-9/L110
Gas outlet (C.G.A. & A.G.A Approved for gas)	6300-7/6381-53	L4285B-LR
Air outlet	6305-7/6381-53	L3185N-LR
Vacuum outlet	6305-7/6381-53	L3185N-LR
Nitrogen outlet	6305-7/6381-53	L3185-LR
Steam outlet	6305-7/6381-53	L3185N-LR

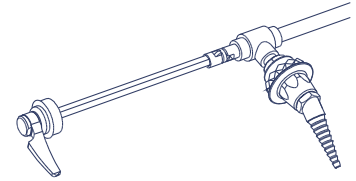

Miscellaneous Fume Hood Accessories

When ordering Fume Hoods, please indicate all required accessories on the **Fume Hood Specifications** Sheet Page 19.

Products	Catalog No.
Low Flow Fume Hood Alarm (Alnor #335) installed on right front post of post of hood with connection to an electrical outlet located on top of the hood	BLF-335
Sash Stop installed on the right side of fume hood	SSL-18
Fume Hood Finished Back Panel	FFBP- __
Fume Hood Ceiling Enclosure	FCE- __
Pre-Piping of all plumbing fixtures in the Fume Hood to top of hood	PPT
Pre-Piping of all plumbing fixtures in the Fume Hood to bottom of hood	PPD

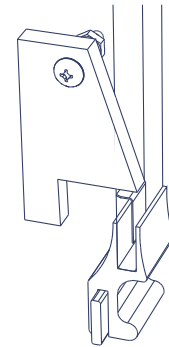

All Pre-Piping Plumbing Fixtures are supplied with the following approved flexible conduits:

Services	Flexible tubing used
Water	3/8" OD Copper Type "L" ASTMB88
Gas	1/4" ID Fairview Rubber Hose Assembly
Air	3/8" OD Copper Type "L" ASTMB88
Vacuum	3/8" OD Copper Type "L" ASTMB88
Nitrogen	3/8" OD Copper Type "L" ASTMB88

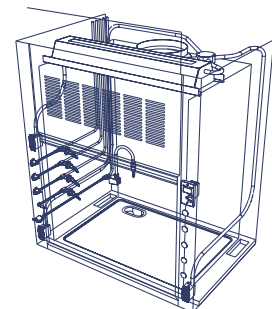

Ordering Information

The following steps will help you in identifying the precise configuration of the hood that's best for you. Just fill in the blanks on the fume hood order sheet.

- Fume Hood Type:** Determine the type of Fume Hood you need as per pages 8 to 13
- Liner Material:** Choose one of the following liner materials
 - White Polyresin panels (FRP): The most frequently used non-metallic liner. Good chemical resistance. Mechanically fastened
 - White Phenolic resin: Non metallic liner. Good chemical resistance. Excellent impact resistance. Mechanically fastened.
 - Stainless steel type 304 panels: T.304 # 4 finish stainless steel panels mechanically fastened.
 - Stainless steel type 316 panels: T.316 # 4 finish stainless steel panels mechanically fastened.
 - Stainless Steel type 304 welded interior: T.304 # 4 all welded interior with seamless covered corners.
 - Stainless Steel type 316 welded interior: T.316 # 4 all welded interior with seamless covered corners.

Fume hood Type	White Polyresin panels (FRP)	White Phenolic panels	Type 304 Stainless steel panels	Type 316 Stainless steel panels	Type 304 Stainless steel welded interior	Type 316 Stainless steel welded interior
Balanced Air (VBA)	Standard	Optional	Optional	Optional	Optional	Optional
Variable Air Volume (VBV)	Standard	Optional	Optional	Optional	Optional	Optional
ADA type (VBH)	Standard	Optional	Optional	Optional	Optional	Optional
Auxiliary Air type (VBI)	Standard	Optional	Optional	Optional	Optional	Optional
Radio-Isotope (VBR)	N/A	N/A	N/A	N/A	Standard	Optional
Perchloric acid (VBP)	N/A	N/A	N/A	N/A	N/A	Standard

- Ceiling enclosure data:** information relative to the space to be enclosed above the fume hood
- Hood size:** exterior width of the fume hood
- Service requirements:** The table below indicates possible service locations.
 - St: standard location
 - Op: Optional location
 - N/A: Service not available at that location
- Plumbing fixtures:**
 - Standard: Mounted to hood / No piping
 - Pre-piped to top: All fixtures are pre-piped in the hood walls and connected to the top of the hood
 - Pre-piped to bottom: All fixtures are pre-piped in the hood walls and connected to the bottom of the hood

Location	Electrical components							Plumbing services								
	400	401	402	403	LS-1 LS-2	Alarm	VAV control cutouts	Cold water	Hot water	Gas	Air	Vacuum	Nitrogen	Steam	Sink	Cup sink
1G	-	-	-	-	St	-	-	-	-	-	-	-	-	-	-	-
2G	-	-	-	-	-	-	-	-	-	Op	Op	Op	Op	Op	-	-
3G	-	-	-	-	-	-	-	-	-	Op	Op	Op	Op	Op	-	-
4G	-	-	-	-	-	-	-	-	-	Op	Op	Op	Op	Op	-	-
5G	-	-	-	-	-	-	-	-	Op	Op	Op	Op	Op	Op	-	-
6G	Op	Op	Op	Op	-	-	-	Op	-	Op	Op	Op	Op	Op	-	-
7G	St	St	St	St	Op	-	-	-	-	Op	Op	Op	Op	Op	-	-
8G	-	-	-	-	-	-	-	-	-	-	-	-	-	-	Op	Op
1D	Op	Op	Op	Op	-	-	Op	Op	-	-	-	-	-	-	-	-
2D	-	-	-	-	-	-	-	-	-	Op	Op	Op	Op	Op	-	-
3D	-	-	-	-	-	-	-	-	-	Op	Op	Op	Op	Op	-	-
4D	-	-	-	-	-	-	-	-	-	Op	Op	Op	Op	Op	-	-
5D	-	-	-	-	-	-	-	-	Op	Op	Op	Op	Op	Op	-	-
6D	Op	Op	Op	Op	-	-	-	Op	-	Op	Op	Op	Op	Op	-	-
7D	St	St	St	St	-	-	-	-	-	-	-	-	-	-	-	-
8D	-	-	-	-	-	-	-	-	-	-	-	-	-	-	Op	Op

- Counter top:** Choose from the different types of counter tops as shown on page 16. Note that stainless steel welded interior hoods come with integral stainless steel tops.
- Base cabinet:** Choose from the base cabinets shown on pages 14 & 15.
- Warranty:** Vanguard Fume hoods and accessories come with a 3 year warranty against defects in material or workmanship.

Fume Hood Specifications

1 Fume hood Type:

- Balanced Air
- Induced Air
- VAV (variable air volume)
- ADA
- Perchloric acid
- Radio-isotope

2 Liner Material:

- Polyresin (FRP)
- Phelonic
- SS panels
- SS welded

3 Ceiling Enclosures Height: _____

- Front
- Right
- Left
- Back

4 Hood size:

- 48"
- 72"
- 60"
- 96"

5 Services required:

- 1L
- 2L
- 3L
- 4L
- 5L
- 6L
- 7L
- 8L

Left side end filler

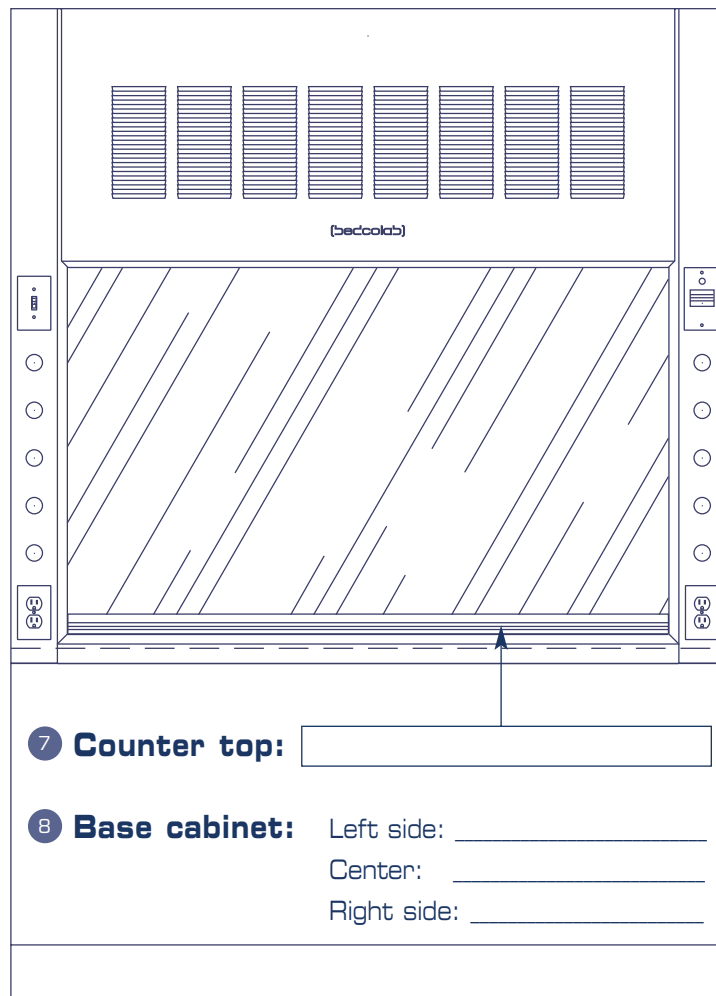

5 Services required:

- 1R
- 2R
- 3R
- 4R
- 5R
- 6R
- 7R
- 8R

Right side end filler

6 Plumbing fixture mounting:

- Installed on hood
- Pre-piping to top
- Pre-piping to bottom

Quantity required: _____

Model #: _____

Customer: _____

Project name: _____

(bedcolab)

Bedcolab Ltd
2305, Francis-Hugues Avenue
Laval, Quebec, Canada H7S 1N5
Phone: 514.384.2820 / 1.800.461.6414
Fax: 514.384.9210
E-mail: info@bedcolab.com
Web Site: www.bedcolab.com
VC-1B

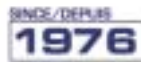

Authorized dealer:



H. H. HAWKINS LTD.
laboratory fume hoods & casework

www.hhhawkins.com
1-800-661-4454